



MH II

Basic Troubleshooting Guide

Glas-Craft, Inc.

5845 WEST 82nd STREET, SUITE 102
INDIANAPOLIS, INDIANA 46278 U.S.A.

Phone (317) 875-5592
Fax (317) 875-5456
E-Mail gcisales@glascraft.com
Web www.glascraft.com

An ISO 9001
Approved
Company



Specialized Dispensing
Equipment and Technology

CE CERTIFIED

CONTENTS

Safety

1

MH II System

TROUBLESHOOTING	4
TROUBLESHOOTING	5
200-240 VOLTS 1 PHASE	6
200-240 VOLTS 3 PHASE	7
380 VOLTS 3 PHASE	8
24 VOLT CIRCUITS FROM TRANSFORMER TO PUSH BUTTONS	9
24 VOLT CIRCUITS FROM TRANSFORMER TO PUSH BUTTONS	10
24 VOLT CIRCUITS PUSH BUTTON TO ISO, POLY, HOSE CONTROLLER	11
24 VOLT CIRCUITS PUSH BUTTON TO ISO, POLY, HOSE CONTROLLER	12
24 VOLT CIRCUITS FOR MOTOR	13
24 VOLT CIRCUITS FOR MOTOR	14
MH II ISO, POLY HEATERS	15
MH II HOSE	16
MH II HOSE	17
MH II HOSE LOW VOLTAGE OVERPRESSURE / OVERTEMP	18
	19

Notes

20

If You Have An Equipment Problem

22

For Your Reference

INSIDE BACK COVER

SAFETY

Safe Handling And Use Of Urethane Foam Equipment

Introduction

Any tool, if used improperly, can be dangerous. Safety is ultimately the responsibility of those using the tool. In like manner, safe operation of polyester processes is the responsibility of those who use such processes and those who operate the equipment. This manual outlines procedures to be followed in conducting polyester operations safely.

All personnel involved in dispensing operations should read and understand this manual. It is most important that equipment operators, maintenance and supervisory personnel understand the requirements for safe operation.

This manual cannot answer every circumstance; each user should examine his own operation, develop his own safety program and be assured that his equipment operators follow correct procedures. Glas-Craft hopes that this manual is helpful to the user and recommends that the precautions in this manual be included in any such program.

Urethane foam systems are comprised of several different chemical compounds, some of which may be hazardous if improperly used.

CAUTION

Particular caution must be taken with respect to the vapors released during the use of urethane foam systems.

Isocyanate compounds are used in urethane foaming operations. The medical history of persons who may be exposed to such isocyanates should be examined. It is recommended that individuals with a history of chronic respiratory ailments should avoid exposure to all isocyanates.

In addition to the manual, Glas-Craft recommends that the user consult the regulations established under the Occupational Safety & Health Act (OSHA), particularly the following sections:

1910.94 Pertaining to ventilation.

1910.106 Pertaining to flammable liquids.

1910.107 Pertaining to spray finishing operations, particularly

Paragraph (m) Organic Peroxides and Dual Component Coatings.

Local codes and authorities also have standards to be followed in the operation of your spraying equipment. Chemical manufacturer's recommendations should be obtained and considered. Your insurance carrier will be helpful in answering questions that arise in your development of safe procedures.

Personnel Safety Equipment

Glas-Craft recommends the following Personal Safety Equipment for conducting safe operations of the Urethane Systems:



EYE PROTECTION



HEARING PROTECTION



BREATHING PROTECTION

Glas-Craft recommends that the user consult the state and local regulations established for all Safety equipment listed.

Operating Safely

In operating urethane foam equipment safely, user should make every effort to:

1. Handle chemicals safely.
2. Provide adequate ventilation.
3. Provide adequate safety equipment (gloves, respirators, safety glasses, protective clothing, etc.) for operators and all others working in areas where they may be exposed to the chemicals or their vapors.
4. Avoid operating equipment which has given any indication of malfunction.
5. Become fully acquainted with the equipment and chemicals used.

Handling Chemicals Safely

Storage of polyisocyanates, diamines, and organic solvents should be isolated and restricted to specially constructed storage rooms. Store chemicals in original containers and according to manufacturer's recommendations listed on the container. Maximum ambient temperatures to which such chemicals should be exposed are specified by the manufacturer and **MUST NOT** be exceeded either in the storage area or in the spraying or pouring area.

To avoid moisture contamination, do not open containers until ready for use. After use, the remaining material should be re-sealed in the original container and stored in areas away from moisture.

During clean-up of spilled isocyanate-component, respirators, gloves and eye protection must be worn. Isocyanates which have been spilled can be controlled by covering them with dry saw dust and/or other absorbent inert materials. Care should be taken to avoid skin contact. The absorbent material and the absorbed isocyanate should be collected promptly, placed in an open-top container, and treated with dilute solutions of ammonium hydroxide and/or alcohol. While being treated in this manner, the material should be in an adequately ventilated area. Clothing on which any material has been spilled should be removed immediately, and cleaned before being worn again.

Clean-Up Solvents

WARNING

A hazardous situation may be present in your pressurized fluid system!

Halogenated Hydrocarbon Solvents can cause an explosion when used with aluminum or galvanized components in a closed (pressurized) fluid system (pumps, heaters, filters, valves, spray guns, tanks, etc.).

The explosion could cause serious injury, death and/or substantial property damage.

Cleaning agents, coatings, paints, etc. may contain Halogenated Hydrocarbon Solvents.

Some Glas-Craft spray equipment includes aluminum or galvanized components and will be affected by Halogenated Hydrocarbon Solvents.

WARNING

If you are now using Halogenated Hydrocarbon solvents in pressurized fluid systems having aluminum or galvanized wetted parts,

IMMEDIATELY TAKE THE FOLLOWING STEPS:

- > Empty system, shut-off, completely depressurize in accordance with equipment service instructions.
- > Remove equipment from service, disassemble in accordance with equipment servicing instructions.
- > Inspect all parts for corrosion and/or wear. Replace any damaged parts.
- > Thoroughly clean all parts of the equipment with a non-halogenated solvent and reassemble in accordance with equipment servicing instructions.
- > Flush equipment with non-halogenated solvent.
- > Do NOT reuse equipment with HHC solvents or with materials containing such solvents.
- > Material suppliers and/or container labels should be consulted to ensure that the solvents used are compatible with your equipment.

NOTE

Glas-Craft is aware of NO stabilizers available to prevent Halogenated Hydrocarbon solvents from reaction under all conditions with aluminum components in a closed fluid system.

TAKE IMMEDIATE ACTION...

Halogenated Hydrocarbon solvents are dangerous when used with aluminum components in a closed fluid system.

A. There are three key elements to the Halogenated Hydrocarbon (HHC) solvent hazard.

1. **The presence of HHC solvents.** 1,1,1-Trichloroethane and Methylene Chloride are the most common of these solvents. However, other HHC solvents are suspect if used; either as part of paint or adhesives formulation, or for clean-up or flushing.

2. **Aluminum or Galvanized Parts.** Most handling equipment contains these elements. In contact with these metals, HHC solvents could generate a corrosive reaction of a catalytic nature.

3. **Equipment capable of withstanding pressure.** When HHC solvents contact aluminum or galvanized parts inside a closed container, such as a pump, spray gun, or fluid handling system, the chemical reaction can, over time, result in a build-up of heat and pressure, which can reach explosive proportions.

When all three elements are present, the result can be an extremely violent explosion. The reaction can be sustained with very little aluminum or galvanized metal: **any amount of aluminum is too much.**

B. The reaction is unpredictable. Prior use of an HHC solvent without incident (corrosion or explosion) does **NOT** mean that such use is safe. These solvents can be dangerous alone (as a clean-up or flushing agent) or when used as a component of a coating material. There is no known inhibitor that is effective under all circumstances. Furthermore, the mixing of HHC solvents with other materials or solvents, such as MEK, alcohol, and toluene, may render the inhibitors ineffective.

C. The use of reclaimed solvents is particularly hazardous. Reclaimers may not add any inhibitors, or may add incorrect amounts of inhibitors, or may add improper types of inhibitors. Also, the possible presence of water in reclaimed solvents could feed the reaction.

D. Anodized or other oxide coatings cannot be relied upon to prevent the explosive reaction. Such coatings can be worn, cracked, scratched, or too thin to prevent contact. There is no known way to make oxide coatings or to employ aluminum alloys, which will safely prevent the chemical reaction under all circumstances.

E. Several solvent suppliers have recently begun promoting HHC solvents for use in coating systems. The increasing use of HHC solvents is increasing the risk. Because of their exemption from many State Implementation Plans as Volatile Organic Compounds (VOC's), their low flammability hazard, and their not being classified as toxic or carcinogenic substances, HHC solvents are very desirable in many respects.

F. Consult your material supplier to determine whether your solvent or coating contains Halogenated Hydrocarbon Solvents.

G. Glas-Craft recommends that you contact your solvent supplier regarding the best non-flammable clean-up solvent with the heat toxicity for your application.

H. If, however, you find it necessary to use flammable solvents, they must be kept in approved, electrically grounded containers.

I. Bulk solvent should be stored in a well-ventilated, separate building, 50 feet away from your main plant.

J. You should allow only enough solvent for one day's use in your work area.

K. "NO SMOKING" signs must be posted and observed in all areas of storage or where solvents and other flammable materials are used.

L. Adequate ventilation (as covered in OSHA Section 1910.94 and NFPA No. 91) is important wherever solvents are stored or used, to minimize, confine and exhaust the solvent vapors.

M. Solvents should be handled in accordance with OSHA Section 1910.106 and 1910.107.

Toxicity of Chemicals

A. Glas-Craft recommends that you consult OSHA Sections 1910.94, 1910.106, 1910.107 and NFPA No. 33, Chapter 14, and NFPA No. 91.

B. Contact your chemical supplier(s) and determine the toxicity of the various chemicals used, as well as the best methods to prevent injury, irritation and danger to personnel.

C. Also determine the best methods of first aid treatment for each chemical used in your plant.

First Aid

If chemicals containing isocyanates are splashed on the skin, they can produce ill effects. Steps to counteract such effects should be started immediately.

1. Apply Tincture of Green Soap, full strength, to the contaminated area. If Tincture of Green Soap is not immediately available, wash the exposed area repeatedly with soap and water. Soap and water is not as desirable as using Tincture of Green Soap

because many isocyanate components are not easily dissolved in water. In addition, soap and water does not form a barrier to the isocyanates.

2. After approximately two to four minutes, wash off the Tincture of Green Soap with water. If there is still an indication of isocyanate present, repeat the application. If the isocyanate contamination is on the facial area, care must be taken to avoid getting the Tincture of Green Soap in the eyes.

3. If the person develops breathing difficulties, oxygen should be administered. Quite often the exposed person will experience residual effects such as coughing spells. **CONTACT PHYSICIAN IMMEDIATELY.**

WARNING

Contact a doctor immediately in the event of an injury and give him the information you have collected. If your information includes first aid instructions, administer first aid immediately while you are contacting the doctor.

4. If a person accidentally swallows isocyanates, large amounts of water should be swallowed immediately. Vomiting should then be induced by patient sticking his finger down his throat, or by swallowing large quantities of warm salt water or warm soapy water. After vomiting, more water should be taken to dilute isocyanate further. **CONTACT PHYSICIAN IMMEDIATELY.**

Ventilation

WARNING

Hazardous concentrations of some chemical vapors exist before they can be smelled. Chemical component suppliers should be contacted to determine at what concentrations the vapors of the chemicals they supply become dangerous, and the procedures and equipment needed to detect such dangerous concentrations. Such equipment should be obtained.

Adequate ventilation must be provided in any area where foam chemicals are sprayed or poured, and wherever the material containers are opened.

In industrial applications, foaming operations should be restricted to specific areas, and proper ventilation should be provided in these areas to prevent chemical vapors from spreading. Spray foaming operations **MUST** be restricted to a spray booth where a minimum exhaust of 100 feet per minute at the face of the booth is provided. Special care should be taken to prevent unsuspecting personnel both inside and outside of the plant from being exposed to chemical vapors. The chemical vapors should be exhausted to atmosphere in such a manner and at a sufficiently low concentration that personnel outside the plant are not exposed to dangerous concentrations of chemical vapors. Refer to OSHA Standards, sub-part G, 1910.107 and particularly sub-section (m) for Federal standards. State and local authorities may have applicable statutes or regulations concerning ventilation.

In contractor applications (for example, at a construction site, inside building or other enclosed space), the forced ventilation

normally provided is likely to be inadequate. These applications, therefore, usually **REQUIRE** the use of forced, fresh air respirators for all persons in the areas where foaming operations are conducted or where the chemical vapors are likely to spread.

In industrial and contractor applications, it is advisable to run frequent tests to determine the exact concentration of isocyanate vapor in the air. Industrial equipment is available for making such determinations. Your chemical supplier can recommend such equipment and procedures.

Proper Safety Equipment

All persons spraying or working in areas where forced air ventilation is not adequate to remove isocyanate vapors from the air **MUST** use an approved (U.S. Bureau of Mines) fresh air supplied respirator.

Respirators should be regularly inspected, cleaned and disinfected according to good practices. Records must be kept of the inspections. The user **MUST** have a medical clearance indicating that he can safely use a respirator.

Respirators must fit securely; beards prevent a tight seal around the face. Eye glasses have to be given special attention and contact lenses are prohibited.

Safety goggles, gloves and other protective devices are suggested for operators of foaming equipment. Refer to OSHA Standards, sub-part 1, 1910.132, 1910.133 and 1910.134 for Federal standards.

IF YOU HAVE ANY QUESTIONS REGARDING THE ABOVE PRECAUTIONS OR ANY SERVICE OR OPERATION PROCEDURES, CALL YOUR GLAS-CRAFT DISTRIBUTOR OR GLAS-CRAFT, INC.

Notice

All statements, information and data given herein are believed to be accurate and reliable but are presented without guaranty, warranty or responsibility of any kind expressed or implied. The user should not assume that all safety measures are indicated or that other measures are not required.

GLAS-CRAFT, Inc.

5845 WEST 82nd STREET, SUITE 102
INDIANAPOLIS, INDIANA 46278 U.S.A.

PHONE (317) 875-5592
5456

FAX (317) 875-

APRIL 1996

MH2 TROUBLE SHOOTING

ALL VOLTAGE CHECKS SHOULD BE BE DONE, BY A LICENSED ELECTRICIAN.

- (1) SELECT THE MACHINE VOLTAGE, AND START VOLTAGE CHECKS.
SHT 1A (200 TO 240 VOLTS 1PH 60 HZ),
SHT. 1B (200 TO 240 VOLTS, 3PH 50/60 HZ)
SHT. 1C (380 VOLTS, 3PH 50 HZ)

- (2) IF THERE IS NO POWER TO HEATER PUSHBUTTON, OR HOSE PUSHBUTTON MAKE SURE EMERGENCY STOP RED KNOB IS NOT PUSHED IN. IF THE EMERGENCY STOP IS OK REFER TO 24 VOLTS FROM TRANSFORMER TO PUSH BUTTONS TROUBLE SHOOTING GUIDE.
(SHT 2, & 2A)

- (2) IF THERE IS POWER TO THE PUSHBUTTONS, BUT NOT TO THE CONTROLLERS, REFER TO PUSH BUTTON TO ISO, POLY, OR HOSE CONTROLLER TROUBLE SHOOTING GUIDE.
(SHT 3, & 3A)

- (3) IF THE MOTOR START PUSH BUTTON LIGHT COMES ON, BUT MOTOR WILL NOT START, REFER TO 24 VOLT CIRCUITS FOR MOTOR.
SHT4, AND 4A.

- (4) IF THE CONTROLLERS DISPLAY, AND THE GREEN LIGHT ON THE CONTROLLER IS ON, BUT HEATERS ARE NOT HEATING REFER TO MH2 ISO POLY HEATERS, TROUBLE SHOOTING GUIDE.
(SHT 5, & 5A,)

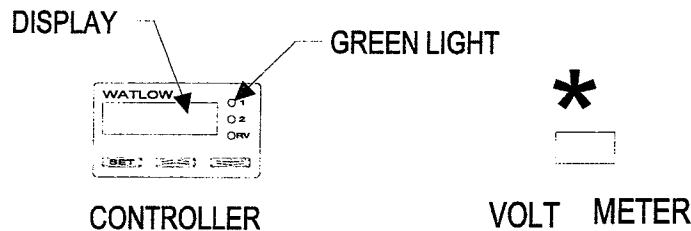

MH2 TROUBLE SHOOTING

ALL VOLTAGE CHECKS SHOULD BE DONE, BY A LICENSED ELECTRICIAN.

- (6) IF THERE IS POWER TO THE PUSHBUTTONS, BUT NOT TO THE CONTROLLERS, REFER TO PUSH BUTTON TO ISO, POLY, OR HOSE CONTROLLER TROUBLE SHOOTING GUIDE.

(SHT 6, & 6A)

SHEET 6B WILL COVER THE SECONDARY SIDE OF THE HOSE TRANSFORMER. IT WILL BE THE LOW VOLTAGE SIDE.

(SHT 6B)

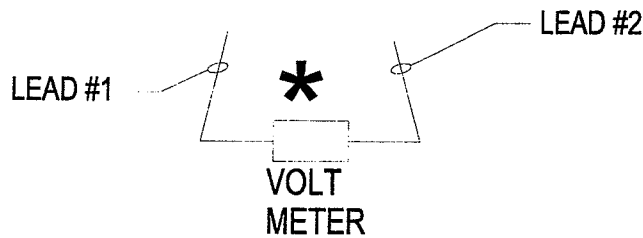
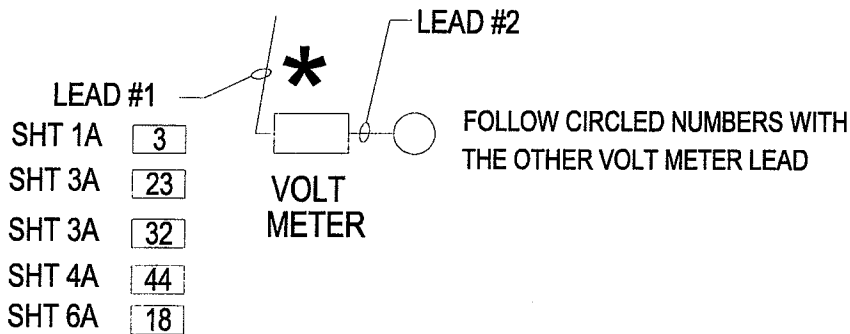

MH2

SHT 1A

MAIN VOLTAGE 200-240 VOLTS 1 PHASE.

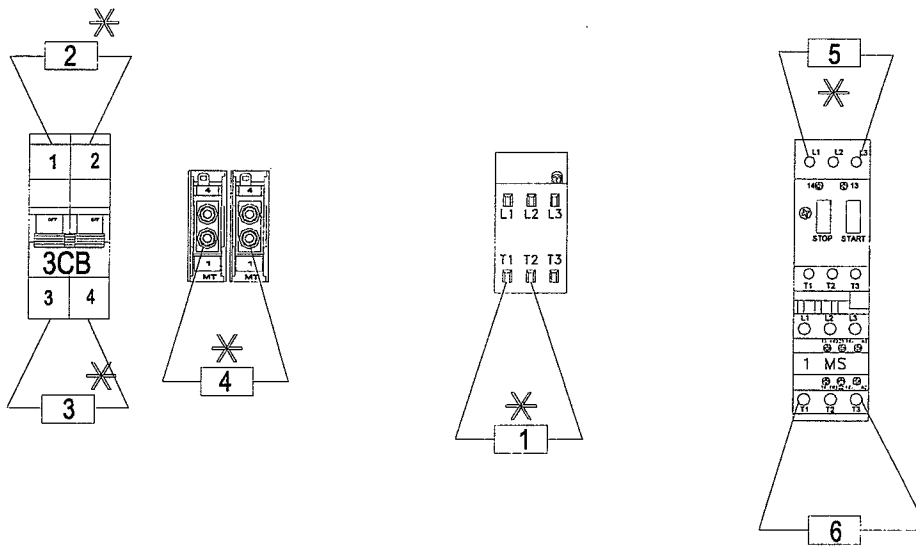

- 1 IF NOT CHECK ON/OFF SWITCH.
- 2 IF NOT CHECK WIRING.
- 3 IF NOT CHECK BREAKER
- 4 IF NOT CHECK WIRING.
- 5 IF NOT CHECK WIRING.
- 5 IF NOT CHECK WIRING.
- 6 IF NOT CHECK THE MOTOR STARTER CONTACT, TO SEE IF IT HAS TRIPPED..

MH2

SHT 1B

MAIN VOLTAGE 200-240 VOLTS 3 PHASE.

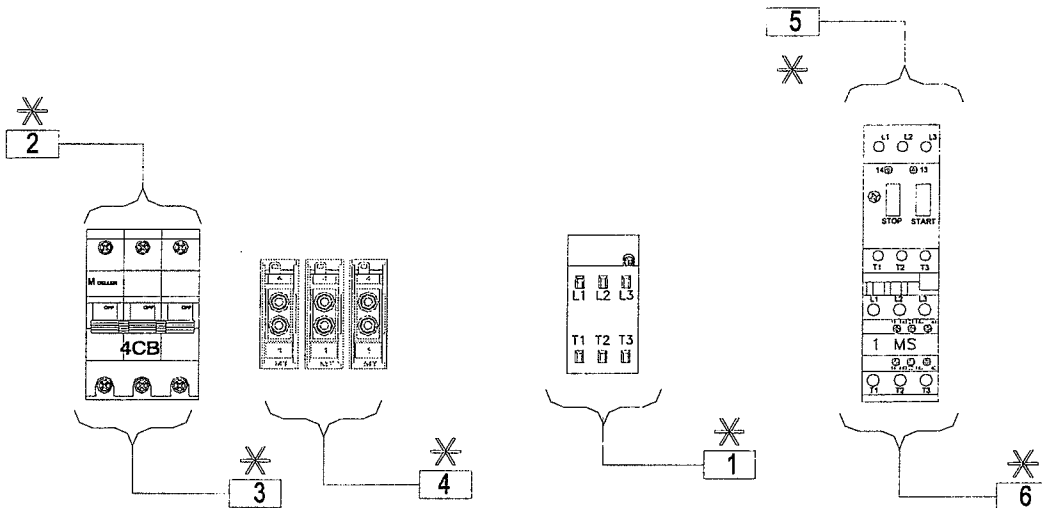

CHECK ALL THREE PHASES

- 1 IF NOT CHECK ON/OFF SWITCH.
- 2 IF NOT CHECK WIRING.
- 3 IF NOT CHECK BREAKER
- 4 IF NOT CHECK WIRING.
- 5 IF NOT CHECK WIRING.
- 5 IF NOT CHECK WIRING.
- 6 IF NOT CHECK THE MOTOR STARTER CONTACT, TO SEE IF IT HAS TRIPPED..

MH2

MAIN VOLTAGE 380 VOLTS 3 PHASE 50 HZ.

SHT 1C

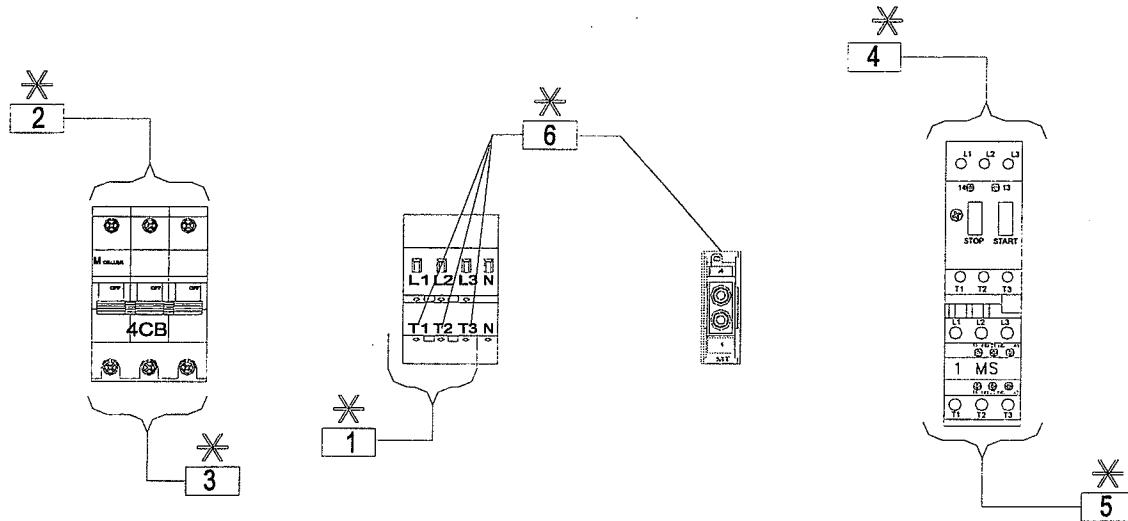

- 1 ALL 3 PHASES SHOULD READ 380 VOLTS, IF NOT CHECK ON/OFF SWITCH.
- 2 ALL 3 PHASES SHOULD READ 380 VOLTS, IF NOT CHECK WIRING.
- 3 ALL 3 PHASES SHOULD READ 380 VOLTS, IF NOT CHECK BREAKER.
- 4 ALL 3 PHASES SHOULD READ 380 VOLTS, IF NOT CHECK WIRING.
- 5 ALL 3 PHASES SHOULD READ 380 VOLTS, IF NOT CHECK THE MOTOR STARTER CONTACT, TO SEE IF IT HAS TRIPPED.
- 6 MEASURE FROM T1, T2, & T3, TO BIG TERMINAL (NEUTRAL) FROM EACH PHASE TO NEUTRAL SHOULD READ 200 TO 240 VOLTS AC.

MH2

SHT 2

24 VOLT CIRCUITS FROM TRANSFORMER TO PUSHBUTTONS.

HEATERS

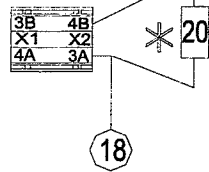

HOSE

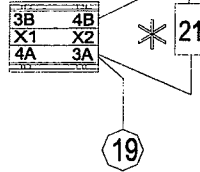

FOLLOW NUMBERS WITH THE OTHER V/M LEAD

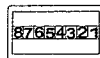

1CONT



2CONT



3CONT



ISO
RESET



POLY
RESET

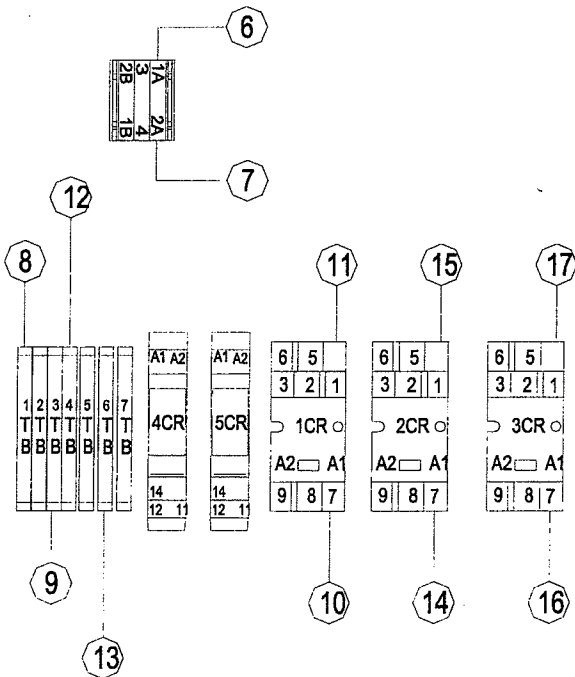
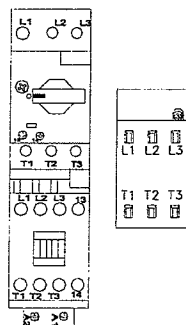
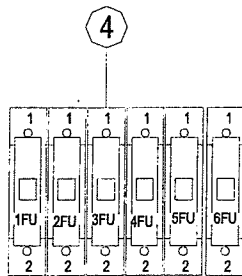
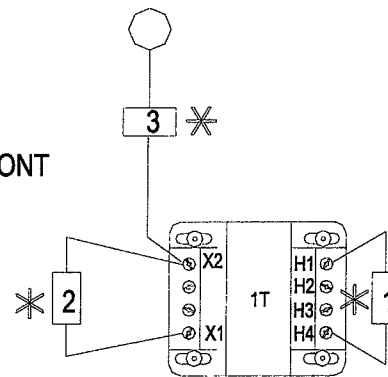
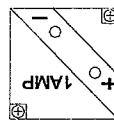

MH 2

SHT 2A

24 VOLTS CIRCUITS FROM TRANSFORMER TO PUSH BUTTONS

- 1 SHOULD READ 200 TO 240 VOLTS AC.
NUMBERS 2 THRU 21 SHOULD READ 24 VOLTS AC.
- 2 IF NOT BAD TRANSF.
- 3 LEAVE ONE LEAD ON X2, AND FOLLOW CIRCLED NUMBERS WITH OTHER LEAD.
 - 4 IF NOT CHECK WIRE CONNECTIONS.
 - 5 IF NOT BAD FUSE.
 - 6 IF NOT CHECK WIRE CONNECTIONS.
 - 7 IF NOT BAD CONTACT BLOCK.
 - 8 IF NOT CHECK WIRE CONNECTIONS.
 - 9 IF NOT CHECK ISO OVERPRESSUE SWITCH.
 - 10 IF NOT CHECK WIRE CONNECTIONS.
 - 11 IF NOT CHECK BAD 1CR RELAY.
 - 12 IF NOT CHECK WIRE CONNECTIONS.
 - 13 IF NOT CHECK POLY OVERPRESSUE SWITCH.
 - 14 IF NOT CHECK WIRE CONNECTIONS.
 - 15 IF NOT CHECK BAD 2CR RELAY.
 - 16 IF NOT CHECK WIRE CONNECTIONS.
 - 17 IF NOT CHECK BAD 3CR RELAY.
 - 18 IF NOT CHECK WIRE CONNECTIONS.
 - 19 IF NOT CHECK WIRE CONNECTIONS.
- 20 IF NOT BAD CONTACT BLOCK.
- 21 IF NOT BAD CONTACT BLOCK.

MH2

SHT 3

24 VOLT CIRCUITS PUSH BUTTON TO ISO, POLY, HOSE CONTROLLER.

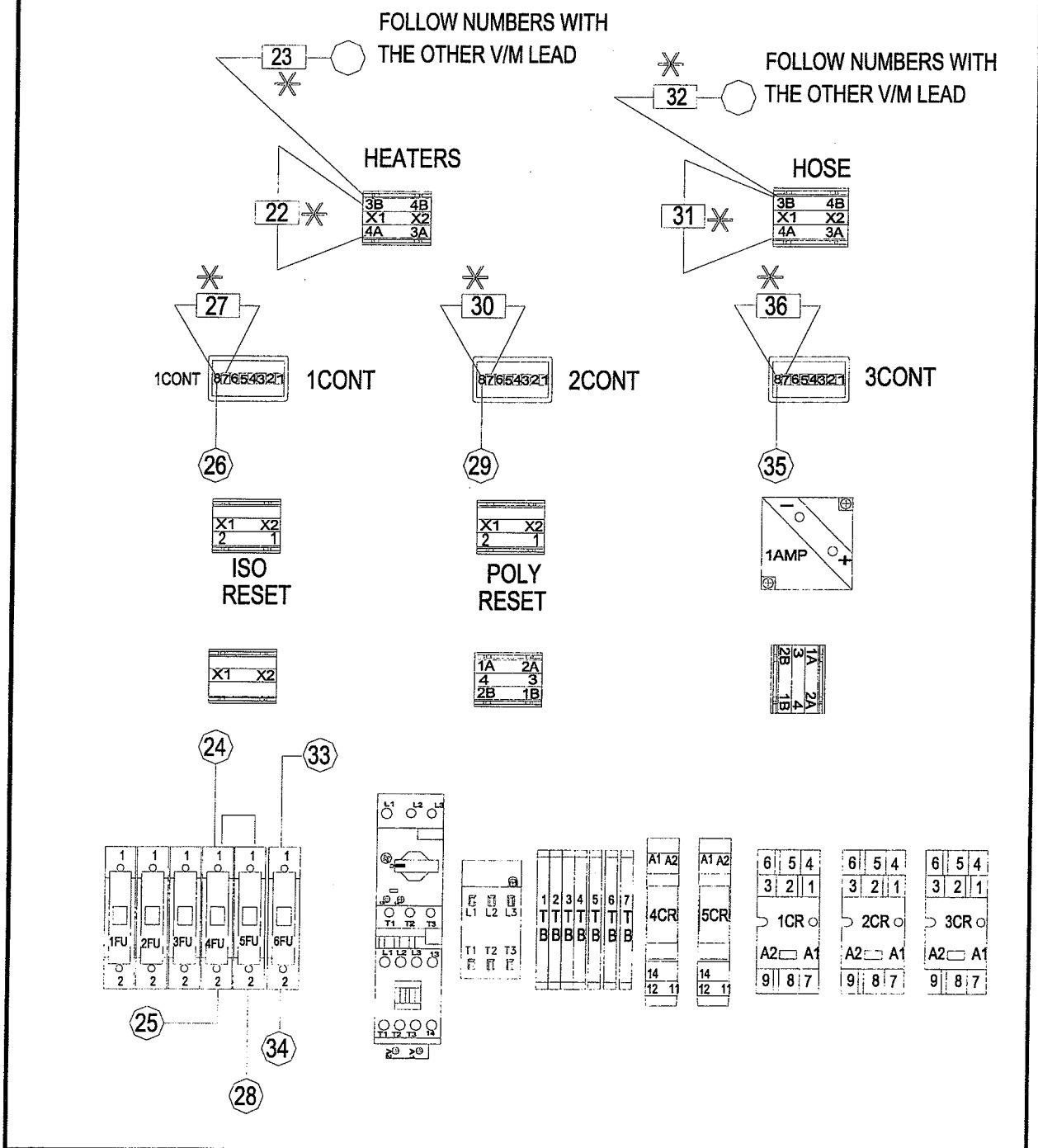

MH2

SHT 3A

24 VOLT CIRCUITS PUSH BUTTON TO ISO, POLY, HOSE CONTROLLER.

NUMBERS 22 THRU 36 SHOULD READ 24 VOLTS AC.

22 IF NOT BAD CONTACT BLOCKS.

23 LEAVE ONE LEAD ON HEATER 3B PUSH BUTTON,
AND FOLLOW CIRCLED NUMBERS WITH OTHER LEAD.

②4 IF NOT CHECK WIRE CONNECTIONS.

②5 IF NOT BAD FUSE.

②6 IF NOT CHECK WIRE CONNECTIONS.

27 IF THERE IS 24 VOLTS AC THEN ISO
CONTROLLER IS BAD, OR LOOSE WIRES

②8 IF NOT BAD FUSE.

②9 IF NOT LOOSE WIRE.

30 IF THERE IS 24 VOLTS AC THEN POLY
CONTROLLER IS BAD, OR LOOSE WIRES

31 IF NOT BAD CONTACT BLOCKS.

32 LEAVE ONE LEAD ON HOSE 3B PUSH BUTTON,
AND FOLLOW CIRCLED NUMBERS WITH OTHER LEAD.

③3 IF NOT CHECK WIRE CONNECTIONS.

③4 IF NOT BAD FUSE.

③5 IF NOT CHECK WIRE CONNECTIONS.

36 IF THERE IS 24 VOLTS AC THEN HOSE
CONTROLLER IS BAD, OR LOOSE WIRES

MH2

SHT 4

24 VOLT CIRCUITS FOR, MOTOR

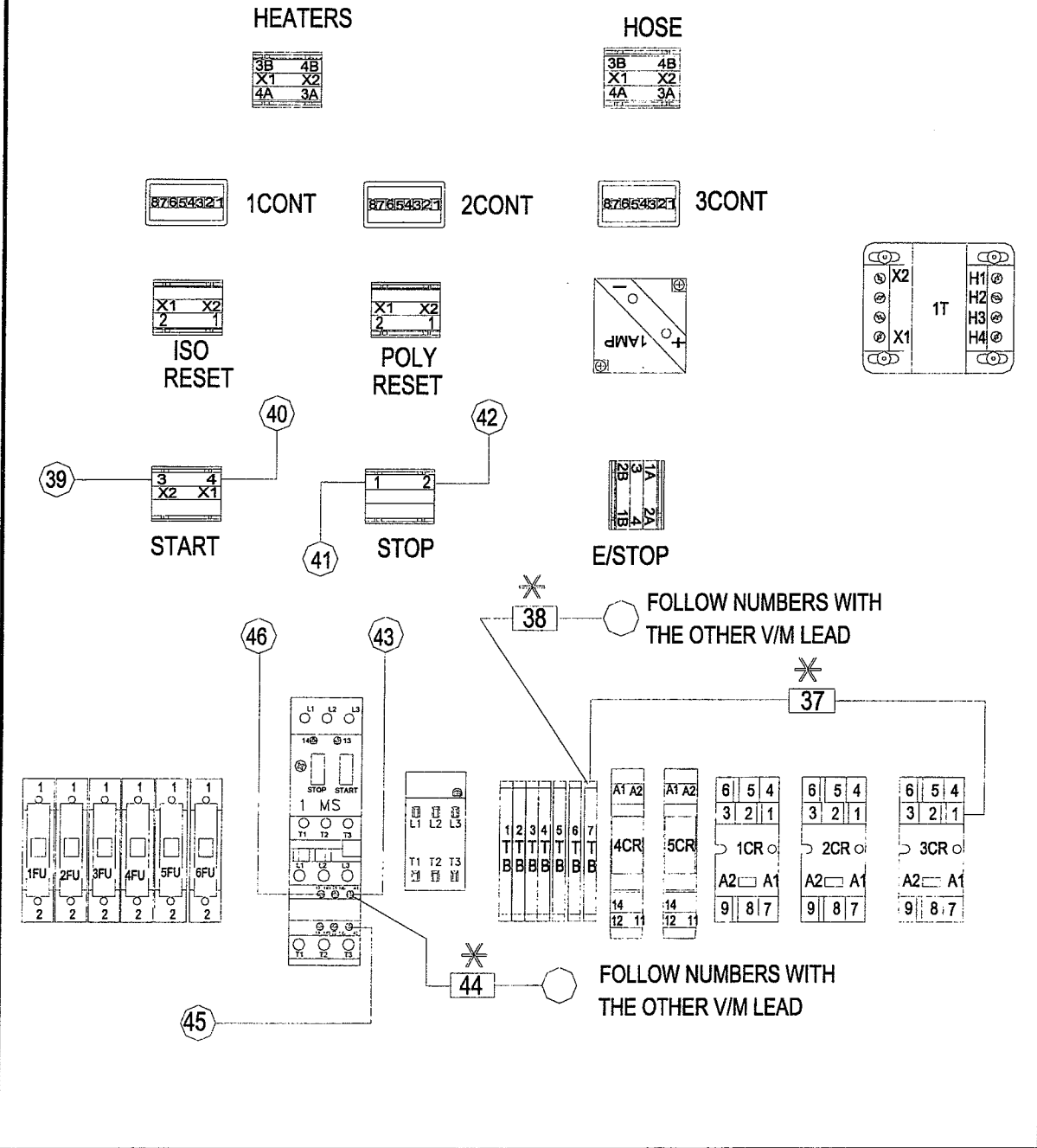

MH2

SHT 4A

24 VOLT CIRCUITS FOR MOTOR

NUMBERS 37 THRU 46 SHOULD READ 24 VOLTS AC

37 SHOULD READ 24 VOLTS.

38 LEAVE ONE LEAD ON #7 TERMINAL BLOCK,
AND FOLLOW CIRCLED NUMBERS WITH OTHER LEAD.

③9 IF NOT CHECK WIRE CONNECTIONS.

MOTOR START BUTTON MUST BE PUSHED DOWN, AND HELD
TO CHECK VOLTAGE FROM 40 TO 46.

④0 IF NOT BAD CONTACT BLOCK.

④1 IF NOT CHECK WIRE CONNECTIONS.

④2 IF NOT BAD CONTACT BLOCK.

④3 IF NOT CHECK WIRE CONNECTIONS.

44 MOVE ONE LEAD TO 1MS-A1 AND FOLLOW
CIRCLED NUMBERS WITH OTHER LEAD.

④5 IF NOT CHECK WIRE CONNECTIONS.

④6 IF NOT CHECK CHECK TO SEE IF MOTOR OVERLOADS
ARE OPENED TRIPPING MOTOR BREAKER.

MH2 ISO, POLY HEATERS

SHT 5

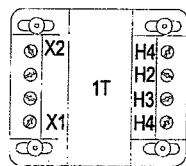
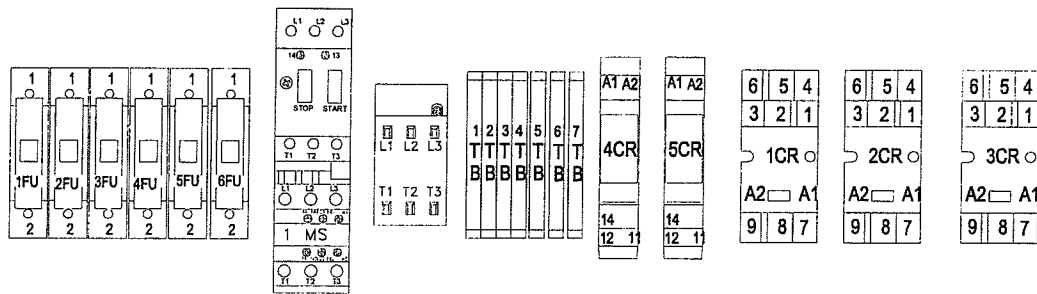
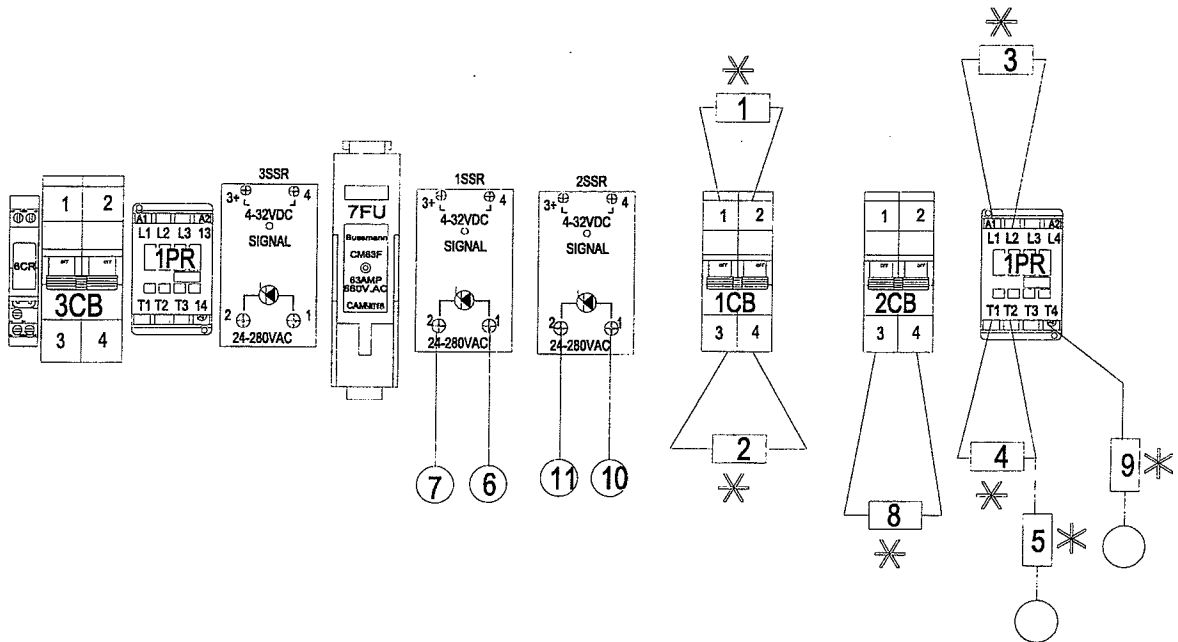

MH2 HOSE

SHT 6

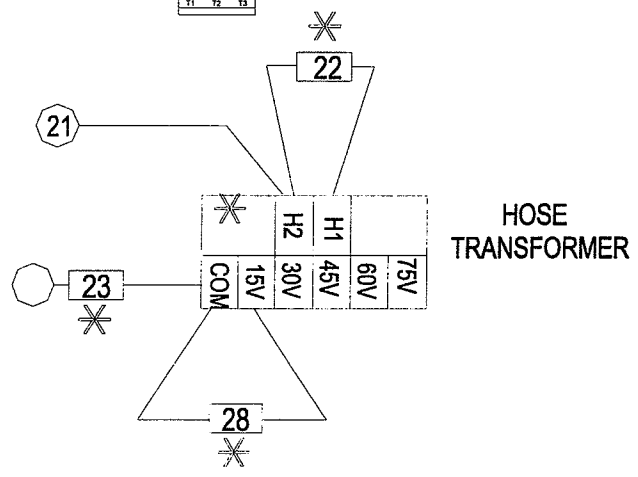
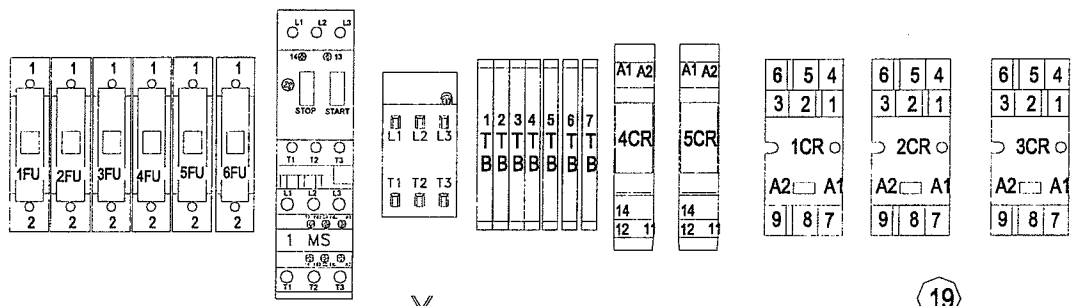
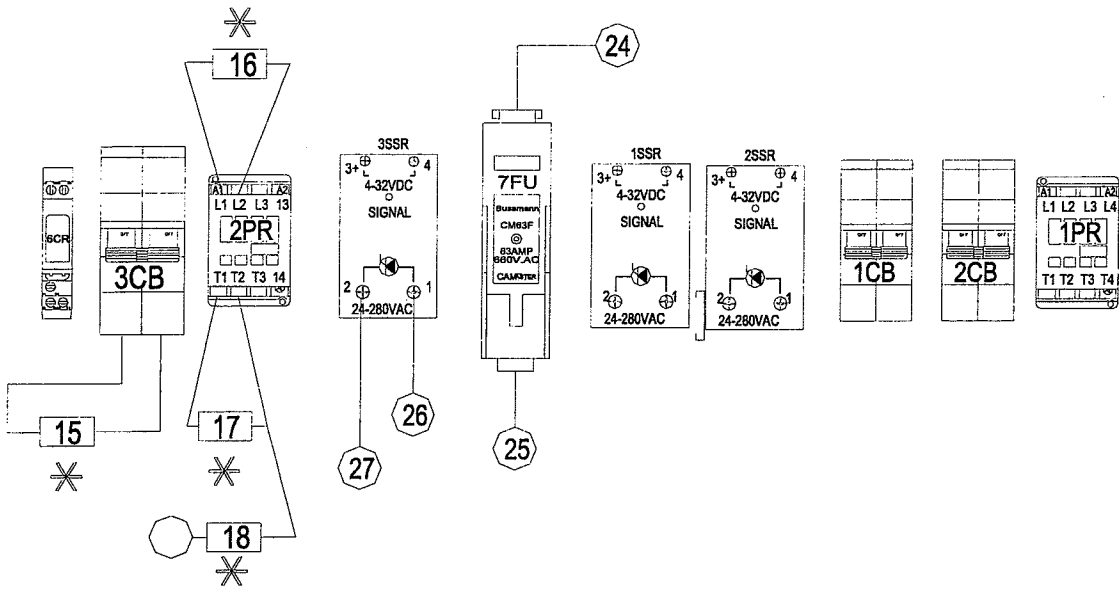

SHT 6A

MH2 HOSE

NUMBERS 15 THRU 22 SHOULD READ 200-240 VOLTS AC

- 15 IF NOT CHECK BREAKER.
- 16 IF NOT CHECK WIRING.
- 17 IF NOT CHECK TO SEE IF THERE IS 24 VOLTS AC ON 2PR A1, & A2. IF YES, CONTACTOR COULD BE BAD.
- 18 LEAVE ONE LEAD ON 2PR-T2, AND FOLLOW CIRCLED NUMBERS WITH OTHER LEAD.
 - 19 IF NOT CHECK WIRING.
 - 20 IF NOT COULD BE BAD METER.
 - 21 IF NOT CHECK WIRING.
 - 22 SHOULD READ 200- 240 VOLTS

6B

IF VOLTAGE IS OK FROM 15 THRU 22 GO TO SHEET ~~3~~ LOW VOLTGE.

SHT 6B

MH2 HOSE LOW VOLTAGE

NUMBERS 22 THRU 28 VOLTAGE READINGS. SEE NOTE.

23 LEAVE ONE LEAD ON COM. OF HOSE TRANSFORMER AND FOLLOW CIRCLED NUMBERS WITH OTHER LEAD.

- 24 IF NOT CHECK WIRING.
- 25 IF NOT BAD FUSE.
- 26 IF NOT CHECK WIRING.
- 27 IF NOT, THEN HOSE 3SSR IS BAD, OR LOOSE WIRES.

28 IF NOT HOSE TRANSFORMER COULD BE BAD.

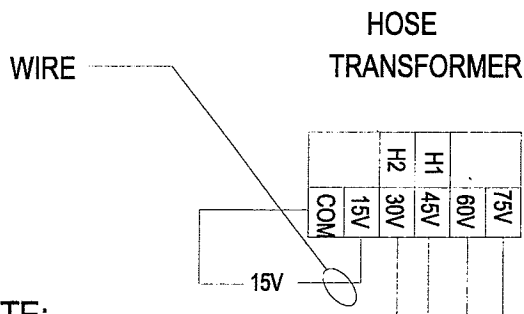

NOTE:

VOLTAGE READINGS WILL BE THE SAME AS THE TAP THE WIRE IS MOVED TO.

OVERPRESSURE/OVERTEMP TROUBLE SHOOTING

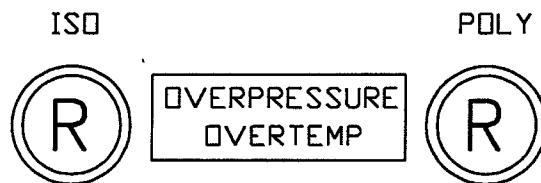

THERE ARE THREE SAFETY CIRCUITS THAT COULD MAKE THESE LIGHTS COME ON.

1. IF THE PRESSURE EXCEEDS THE PRESET PRESSURE SETTING. WHICHEVER SIDE GOES OVER PRESSURE THE LIGHT WILL COME ON, THE HEATERS WILL SHUT OFF, AND THE MOTOR WILL STOP. AFTER PRESSURE IS NORMAL, PUSH RESET BUTTON.
2. IF THE CONTROLLER PRESET HI ALARM TEMP. IS EXCEEDED. (230°) THE SAME SHUT OFF PROCEDURE AS DISCRIBED ABOVE WILL APPLY. COLD MATERIAL MUST BE RUN TO COOL THE HEATER, BEFORE THE RESET BUTTON CAN RESET.
3. THE OVERTEMP SWITCHIES ON THE HEATER TUBES ARE FOR A THIRD SHUTDOWN SAFETY FEATURE, AND WILL SHUT THE UNIT DOWN THE SAME AS #2.

MICRO II, MAXI II, AND MAXI III

RESISTANCE READINGS FOR ISO/POLY
THERMOCOUPLE, AND HEAT RODS.

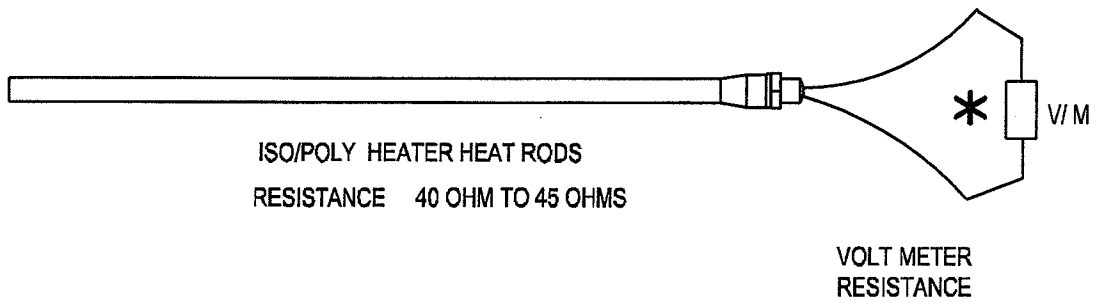
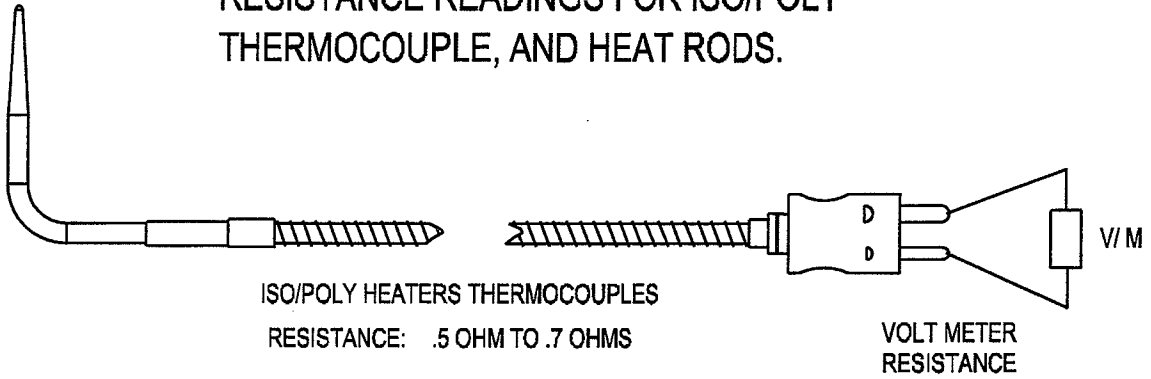

VOLT METER
RESISTANCE

V/M

HOSE THERMOCOUPLE
RESISTANCE 5 OHM TO 7 OHMS

IF YOU HAVE AN EQUIPMENT PROBLEM...

SPRAY GUN MODEL NO. _____
 CATALYST SYSTEM TYPE _____
 COMPRESSOR MODEL NO. _____
 TYPE of MATERIAL BEING SPRAYED _____
 TYPE of CATALYST BEING SPRAYED _____
 SYSTEM GAUGE PRESSURES
 ISO _____ PSI
 POLY _____ PSI
 MAIN AIR _____ PSI
 AIR LINE PRESSURE at SYSTEM _____ PSI
 VOLUME _____ CFM
 COMPRESSOR SIZE _____ HP
 COMPRESSOR to SYSTEM SUPPLY LINE SIZE _____ INCHES

If you have a problem that requires Distributor or Glas-Craft Service Department help, gather the following information BEFORE you pick-up the telephone.

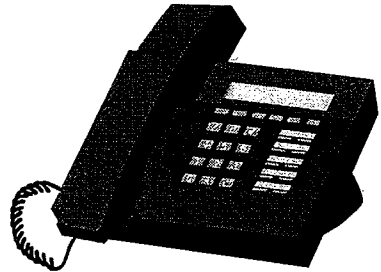

	Model No.	Serial No.
SPRAY GUN		
SYSTEM		
TYPE of MATERIAL BEING SPRAYED		
SYSTEM GAUGE PRESSURES		
ISO HEATER GAUGE		PSI
POLY HEATER GAUGE		PSI
MATERIAL PUMP AIR MOTOR		PSI
MAIN AIR LINE PRESSURE at SYSTEM		PSI
MAIN AIR LINE VOLUME		CFM
COMPRESSOR SIZE		HP
COMPRESSOR to SYSTEM SUPPLY LINE SIZE		INCHES

Have a general equipment or operation question? You can contact Glas-Craft Service Department via E-Mail at gciservice@glascraft.com

FOR YOUR REFERENCE

DATE PURCHASED _____

DISTRIBUTOR _____

CONTACT _____

PHONE _____

Manufacturers of ...

*Fixed and Variable Ratio Systems and Equipment for Polyurethane, Polyurea
and Hybrid Materials Spray, Pour and Injection*

Micro II, Maxi II, Super Maxi, Mini III, MX, MX II, MH, MH II & MH III

SYSTEMS and EQUIPMENT for...

- *SPRAY, POUR & INJECT*
- *FIXED & VARIABLE RATIO SYSTEMS*
- *EQUIPMENT FOR POLYURETHANE FOAMS, COATINGS and
POLYUREAS*

...featuring the patented Probler Spray/Pour Gun

LPA Series

*"Low Pressure, AIR ASSIST CONTAINMENT, Airless
External-Mix"*

*Gel-Coat, Wet-Out, & Chopper
Systems and Equipment*

INDy Series

"Internal-Mix Non-Atomized Dispense Systems"

*Gel-Coat, Wet-Out,
Chopper & Pressure Fed Roller
Systems and Equipment*

**For more information concerning any of these Glas-Craft products,
contact your local authorized Glas-Craft distributor, or**

Glas-Craft, Inc.

5845 WEST 82nd STREET, SUITE 102

PHONE (317) 875-5592

E-Mail gcisales@glascraft.com

INDIANAPOLIS, INDIANA 46278 U.S.A.

FAX (317) 875-5456

Web Site www.glascraft.com

Quality and Performance...
GENUINE GLAS-CRAFT

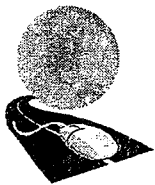

www.glascraft.com

GC-1380

5845 WEST 82nd STREET
INDIANAPOLIS, INDIANA 46278 U.S.A.

Phone (317) 875-5592

Fax (317) 875-5456

E-Mail gcisales@glascraft.com

REVISED APRIL 2004